



rtc[®]

COUPLING TECHNOLOGY



200

rtc TYPE



Temperature Range - Temperaturbereich

Nitrile (N)	-20°C + 100°C (- 4°F + 212°F)
FPM (V)	-20°C + 180°C (- 4°F + 356°F)
EPDM (Ethylene Propylene)	-40°C + 150°C (- 40°F + 302°F)

Max. Working Pressure - Max. Betriebsdruck

Please Check the individual tables

Flow size - Nennweite

rtc 200.04	4 mm
rtc 200.05	6 mm
rtc 200.06	6 mm
rtc 200.07	7 mm
rtc 200.09	9 mm
rtc 200.12	12 mm
rtc 200.19	19 mm
rtc 200.32	32 mm
rtc 200.50	50 mm

Material of Brass Coupler - MS Version

Material für die Messingversion - MS Version

Socket body - Kupplungsgrundkörper	Brass - Messing
Valve - Ventil	Brass - Messing
Springs - Federn	Stainless Steel - Edelstahl
Balls - Kugeln	Stainless Steel - Edelstahl
Locking Ring - Sprengring	Stainless Steel - Edelstahl

Plug - Nippel Brass - Messing

Material of Steel Coupler - ST Version

Material für die Stahlversion - ST Version

Socket body - Kupplungsgrundkörper	Steel zinc plated - Stahl verzinkt
Valve - Ventil	Brass - Messing
Springs - Federn	Stainless Steel - Edelstahl
Balls - Kugeln	Stainless Steel - Edelstahl
Locking Ring - Sprengring	Stainless Steel - Edelstahl

Plug - Nippel Steel zinc plated -
Stahl verzinkt

Compatible - Kompatibilität

rtc 200.04	LP-004
rtc 200.05	LP-006
rtc 200.06	SP-006
rtc 200.07	LP-007
rtc 200.09	SP-009
rtc 200.12	LP-012
rtc 200.19	LP-019
rtc 200.32	LP-032
rtc 200.50	LP-050

Options / Optionen	Add	Example Code
Brass Messing	MS	200.04 SMB 13- MS
Steel Stahl	ST	200.04 SMB 13- ST
Stainless Steel AISI 303 Edelstahl AISI 303	S3	200.04 SMB 13- S3
Stainless Steel AISI 316L Edelstahl AISI 316L	S6	200.04 SMB 13- S6
Nickel Plated Vernickelt	NI	200.04 SMB 13- MS-NI
Zinc Nickel Plated Zink Nickel Beschichtung	CN	200.04 SMB 13- MS-CN
Chromium Plated Verchromt	CH	200.04 SMB 13- MS-CH
Chemical Nickel Plated Chemisch Vernickelt	KN	200.04 SMB 13- ST-KN
Safety Sicherheit	S	200.04 SMB 13- ST-S



rtc TYPE 200.04

Sockets & Plugs / Kupplungen & Nippel



Compatible: LP-004

Technical Spec. - Technische Daten	Brass - MS	Stainless - S3	Steel - ST
Nominal Ø (mm) - Nennweite Ø (mm)	4 mm	4 mm	4 mm
Nominal Area (mm ²) - Fläche (mm ²)	13 mm ²	13 mm ²	13 mm ²
Maximum Working Pressure (Bar - PSI)	20 bar	20 bar	60 bar
Maximaler Betriebsdruck (Bar - PSI)	290 PSI	290 PSI	870 PSI

Flow Rate vs Pressure Drop Graph / Durchflussrate vs Druckabfall

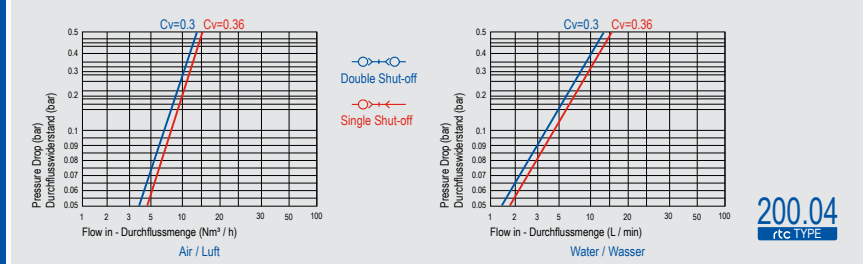

200.04
rtc TYPE

rtc TYPE 200.05

Sockets & Plugs / Kupplungen & Nippel



Compatible: LP-006

Technical Spec. - Technische Daten	Brass - MS	Stainless - S3	Steel - ST
Nominal Ø (mm) - Nennweite Ø (mm)	6 mm	6 mm	6 mm
Nominal Area (mm ²) - Fläche (mm ²)	30 mm ²	30 mm ²	30 mm ²
Maximum Working Pressure (Bar - PSI)	40 bar	40 bar	60 bar
Maximaler Betriebsdruck (Bar - PSI)	580 PSI	580 PSI	870 PSI

Flow Rate vs Pressure Drop Graph / Durchflussrate vs Druckabfall

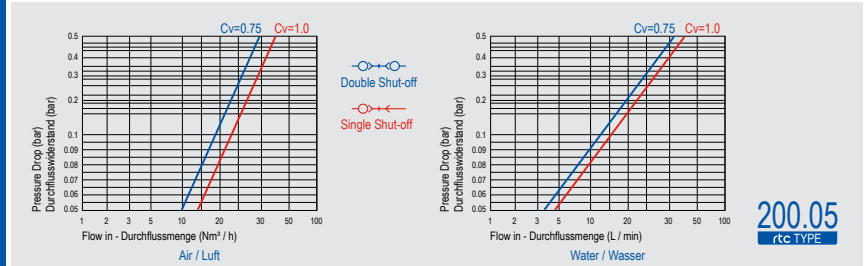

200.05
rtc TYPE

rtc TYPE 200.06

Sockets & Plugs / Kupplungen & Nippel



Compatible: SP-006

Technical Spec. - Technische Daten	Brass - MS	Stainless - S3	Steel - ST
Nominal Ø (mm) - Nennweite Ø (mm)	6 mm	6 mm	6 mm
Nominal Area (mm ²) - Fläche (mm ²)	30 mm ²	30 mm ²	30 mm ²
Maximum Working Pressure (Bar - PSI)	60 bar	60 bar	100 bar
Maximaler Betriebsdruck (Bar - PSI)	870 PSI	870 PSI	1450 PSI

Flow Rate vs Pressure Drop Graph / Durchflussrate vs Druckabfall

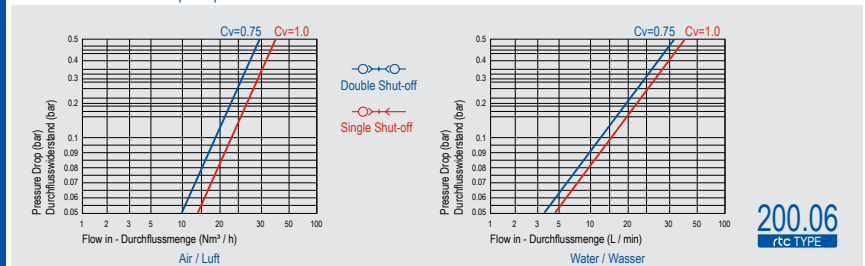

200.06
rtc TYPE



Sockets & Plugs / Kupplungen & Nippel

TYPE 200.07 **rtc**

Technical Spec. - Technische Daten	Brass - MS	Stainless - S3	Steel - ST
Nominal Ø (mm) - Nennweite Ø (mm)	7 mm	7 mm	7 mm
Nominal Area (mm ²) - Fläche (mm ²)	40 mm ²	40 mm ²	40 mm ²
Maximum Working Pressure (Bar - PSI)	40 bar	40 bar	50 bar
Maximaler Betriebsdruck (Bar - PSI)	580 PSI	580 PSI	725 PSI

Flow Rate vs Pressure Drop Graph / Durchflussrate vs Druckabfall

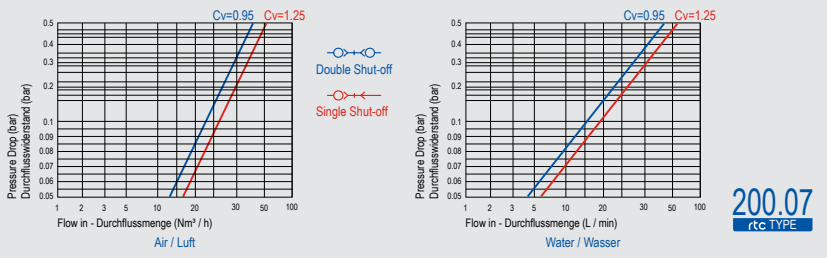

Compatible: LP-007



Sockets & Plugs / Kupplungen & Nippel

TYPE 200.09 **rtc**

Technical Spec. - Technische Daten	Brass - MS	Stainless - S3	Steel - ST
Nominal Ø (mm) - Nennweite Ø (mm)	9 mm	9 mm	9 mm
Nominal Area (mm ²) - Fläche (mm ²)	64 mm ²	64 mm ²	64 mm ²
Maximum Working Pressure (Bar - PSI)	40 bar	40 bar	100 bar
Maximaler Betriebsdruck (Bar - PSI)	580 PSI	580 PSI	1450 PSI

Flow Rate vs Pressure Drop Graph / Durchflussrate vs Druckabfall

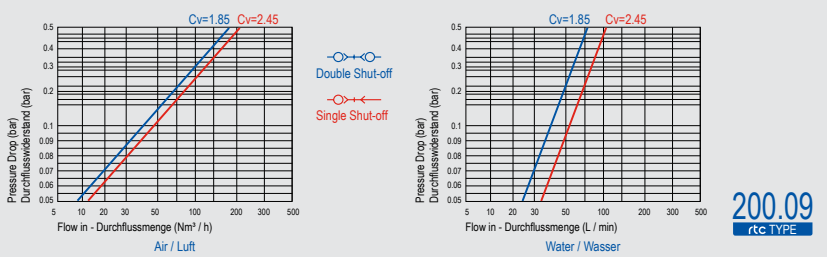

Compatible: SP-009



Sockets & Plugs / Kupplungen & Nippel

TYPE 200.12 **rtc**

Technical Spec. - Technische Daten	Brass - MS	Stainless - S3	Steel - ST
Nominal Ø (mm) - Nennweite Ø (mm)	12 mm	12 mm	12 mm
Nominal Area (mm ²) - Fläche (mm ²)	120 mm ²	120 mm ²	120 mm ²
Maximum Working Pressure (Bar - PSI)	30 bar	30 bar	50 bar
Maximaler Betriebsdruck (Bar - PSI)	435 PSI	435 PSI	725 PSI

Flow Rate vs Pressure Drop Graph / Durchflussrate vs Druckabfall

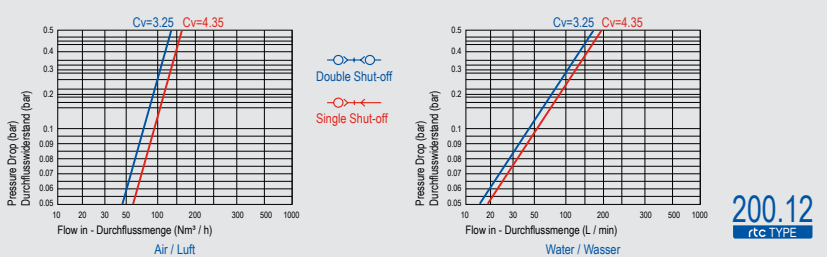

Compatible: LP-012

rtc TYPE 200.19

Sockets & Plugs / Kupplungen & Nippel



Compatible: LP-019

Technical Spec. - Technische Daten	Brass - MS	Stainless - S3	Steel - ST
Nominal Ø (mm) - Nennweite Ø (mm)	19 mm	19 mm	19 mm
Nominal Area (mm ²) - Fläche (mm ²)	300 mm ²	300 mm ²	300 mm ²
Maximum Working Pressure (Bar - PSI)	30 bar	30 bar	50 bar
Maximaler Betriebsdruck (Bar - PSI)	435 PSI	435 PSI	725 PSI

Flow Rate vs Pressure Drop Graph / Durchflussrate vs Druckabfall

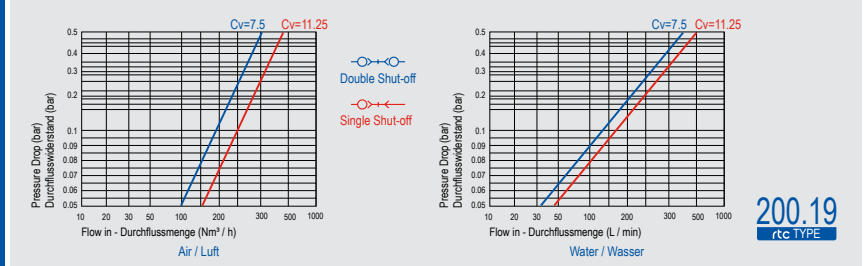

200.19
rtc TYPE

rtc TYPE 200.32

Sockets & Plugs / Kupplungen & Nippel



Compatible: LP-032

Technical Spec. - Technische Daten	Brass - MS	Stainless - S3	Steel - ST
Nominal Ø (mm) - Nennweite Ø (mm)	32 mm	32 mm	32 mm
Nominal Area (mm ²) - Fläche (mm ²)	800 mm ²	800 mm ²	800 mm ²
Maximum Working Pressure (Bar - PSI)	30 bar	30 bar	30 bar
Maximaler Betriebsdruck (Bar - PSI)	435 PSI	435 PSI	435 PSI

Flow Rate vs Pressure Drop Graph / Durchflussrate vs Druckabfall

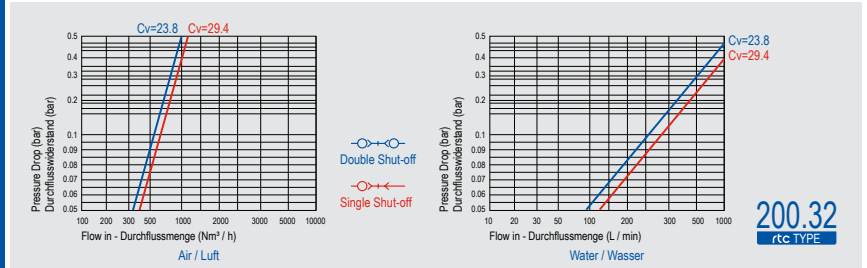

200.32
rtc TYPE

rtc TYPE 200.50

Sockets & Plugs / Kupplungen & Nippel



Compatible: LP-050

Technical Spec. - Technische Daten	Brass - MS	Stainless - S3	Steel - ST
Nominal Ø (mm) - Nennweite Ø (mm)	50 mm	50 mm	50 mm
Nominal Area (mm ²) - Fläche (mm ²)	2000 mm ²	2000 mm ²	2000 mm ²
Maximum Working Pressure (Bar - PSI)	20 bar	20 bar	30 bar
Maximaler Betriebsdruck (Bar - PSI)	290 PSI	290 PSI	435 PSI

Flow Rate vs Pressure Drop Graph / Durchflussrate vs Druckabfall

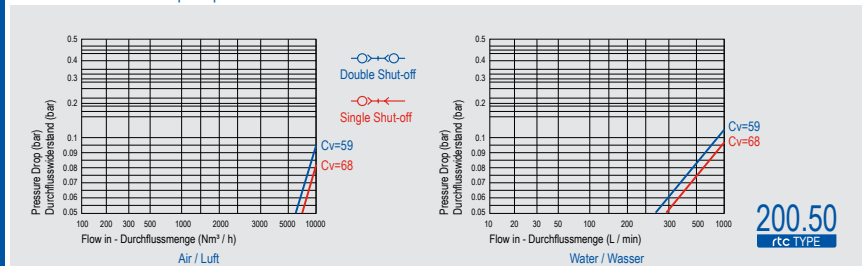

200.50
rtc TYPE



Female thread socket / Kupplung mit Innengewinde

TYPE 200 **rtc**

Socket / Kupplung	Size Größe	Order No / Bestellnr. With Valve / Mit Ventil	Order No / Bestellnr. Without Valve / Ohne Ventil	Ød	Ød1	L	HEX.
	04	200.04 SFB 10	200.04 SFF 10	BSP 1/8	18	45.5	14
	06	200.05 SFB 13	200.05 SFF 13	BSP 1/4	25	57	19
		200.05 SFB 17	200.05 SFF 17	BSP 3/8	25	58	22
	06	200.06 SFB 13	200.06 SFF 13	BSP 1/4	22	57	19
		200.06 SFB 17	200.06 SFF 17	BSP 3/8	22	58	22
	07	200.07 SFB 17	200.07 SFF 17	BSP 3/8	30	68	24
		200.07 SFB 21	200.07 SFF 21	BSP 1/2	30	71	27
	09	200.09 SFB 17	200.09 SFF 17	BSP 3/8	28	68	25
		200.09 SFB 21	200.09 SFF 21	BSP 1/2	28	71	25
	12	200.12 SFB 21	200.12 SFF 21	BSP 1/2	40	81	32
200.12 SFB 26		200.12 SFF 26	BSP 3/4	40	83	32	
19	200.19 SFB 26	200.19 SFF 26	BSP 3/4	54	94	46	
	200.19 SFB 33	200.19 SFF 33	BSP 1	54	98	46	
32	200.32 SFB 48	-	BSP 1-1/2	82	126	75	
	200.32 SFB 60	-	BSP 2	82	130	75	
32	-	200.32 SFF 42	BSP 1-1/4	82	89	70	
	-	200.32 SFF 48	BSP 1-1/2	82	89	70	
	-	200.32 SFF 60	BSP 2	82	89	70	
50	200.50 SFB 60	-	BSP 2	112	158	100	
	200.50 SFB 75	-	BSP 2-1/2	112	167	100	
50	-	200.50 SFF 60	BSP 2	112	107	100	
	-	200.50 SFF 75	BSP 2-1/2	112	107	100	

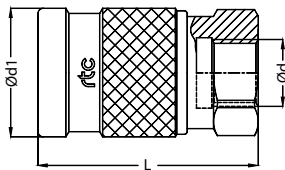
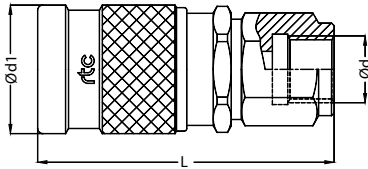

Free-Flow Coupling
Kupplung ohne Ventil



Male thread socket / Kupplung mit Aussengewinde

TYPE 200 **rtc**

Socket / Kupplung	Size Größe	Order No / Bestellnr. With Valve / Mit Ventil	Order No / Bestellnr. Without Valve / Ohne Ventil	Ød	Ød1	L	L1	HEX.
	04	200.04 SMB 10-00	200.04 SMF 10-00	BSP 1/8	18	45.5	10	14
		200.04 SMB 13-00	200.04 SMF 13-00	BSP 1/4	18	46.4	11	14
	06	200.05 SMB 13-00	200.05 SMF 13-00	BSP 1/4	25	58	11	19
		200.05 SMB 17-00	200.05 SMF 17-00	BSP 3/8	25	59	12	19
		200.05 SMB 21-00	200.05 SMF 21-00	BSP 1/2	25	62	15	22
	06	200.06 SMB 13-00	200.06 SMF 13-00	BSP 1/4	22	58	11	19
		200.06 SMB 17-00	200.06 SMF 17-00	BSP 3/8	22	59	12	19
		200.06 SMB 21-00	200.06 SMF 21-00	BSP 1/2	22	62	15	22
	07	200.07 SMB 17-00	200.07 SMF 17-00	BSP 3/8	30	68	12	24
		200.07 SMB 21-00	200.07 SMF 21-00	BSP 1/2	30	71	15	24
09	200.09 SMB 17-00	200.09 SMF 17-00	BSP 3/8	28	68	12	25	
	200.09 SMB 21-00	200.09 SMF 21-00	BSP 1/2	28	71	15	25	
12	200.12 SMB 21-00	200.12 SMF 21-00	BSP 1/2	40	82	15	32	
	200.12 SMB 26-00	200.12 SMF 26-00	BSP 3/4	40	84	17	32	
	200.12 SMB 33-00	200.12 SMF 33-00	BSP 1	40	87	20	36	

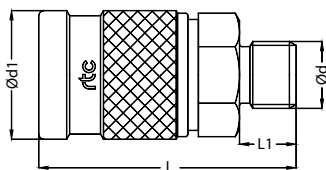
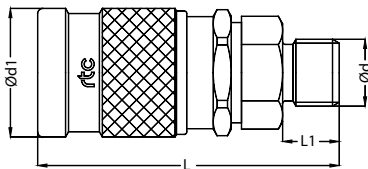

Free-Flow Coupling
Kupplung ohne Ventil

rtc TYPE 200

Male thread socket / Kupplung mit Aussengewinde



Socket / Kupplung	Size Größe	Order No / Bestellnr. With Valve / Mit Ventil	Order No / Bestellnr. Without Valve / Ohne Ventil	Ød	Ød1	L	L1	HEX.
	19	200.19 SMB 26-00	200.19 SMF 26-00	BSP 3/4	54	100	17	46
		200.19 SMB 33-00	200.19 SMF 33-00	BSP 1	54	103	20	46
		200.19 SMB 42-00	200.19 SMF 42-00	BSP 1-1/4	54	103	20	46
	32	200.32 SMB 48-00	-	BSP 1-1/2	82	139	22	75
		200.32 SMB 60-00	-	BSP 2	82	143	26	75
<p>Free-Flow Coupling Kupplung ohne Ventil</p>	32	-	200.32 SMF 48-00	BSP 1-1/2	82	109	22	70
		-	200.32 SMF 60-00	BSP 2	82	113	26	70
	50	200.50 SMB 60-00	-	BSP 2	112	162	26	100
		200.50 SMB 75-00	-	BSP 2-1/2	112	164	30	100
<p>Free-Flow Coupling Kupplung ohne Ventil</p>	50	-	200.32 SMF 60-00	BSP 2	112	133	26	100
		-	200.32 SMF 75-00	BSP 2-1/2	112	137	30	100

rtc TYPE 200

Male thread socket with sealing edge / Kupplung mit Aussengewinde / Abdichtung am Rand



Socket / Kupplung	Size Größe	Order No / Bestellnr. With Valve / Mit Ventil	Order No / Bestellnr. Without Valve / Ohne Ventil	Ød	Ød1	L	L1	HEX.
	06	200.05 SMB 17-SE	200.05 SMF 17-SE	BSP 3/8	25	64	12	27
	06	200.06 SMB 17-SE	200.06 SMF 17-SE	BSP 3/8	22	64	12	27
	07	200.07 SMB 17-SE	200.07 SMF 17-SE	BSP 3/8	30	71	12	27
	12	200.12 SMB 21-SE	200.12 SMF 21-SE	BSP 1/2	40	84	14	32
	19	200.19 SMB 26-SE	200.19 SMF 26-SE	BSP 3/4	54	102	16	46

rtc TYPE 200

Male thread socket with 60° sealing cone / Kupplung mit Aussengewinde 60° Dichtkonus



Socket / Kupplung	Size Größe	Order No / Bestellnr. With Valve / Mit Ventil	Order No / Bestellnr. Without Valve / Ohne Ventil	Ød	Ød1	L	L1	HEX.
	06	200.05 SMB 13	200.05 SMF 13	BSP 1/4	25	58	11	19
		200.05 SMB 17	200.05 SMF 17	BSP 3/8	25	59	12	19
		200.05 SMB 1415	200.05 SMF 1415	M14x1.5	25	57	10	19
	06	200.06 SMB 13	200.06 SMF 13	BSP 1/4	22	58	11	19
		200.06 SMB 17	200.06 SMF 17	BSP 3/8	22	59	12	19
		200.06 SMB 1415	200.06 SMF 1415	M14x1.5	22	57	10	19
	07	200.07 SMB 17	200.07 SMF 17	BSP 3/8	30	68	12	24
		200.07 SMB 1615	200.07 SMF 1615	M16x1.5	30	67	11	24
	12	200.12 SMB 13	200.12 SMF 13	BSP 1/2	40	82	15	32
		200.12 SMB 17	200.12 SMF 17	BSP 3/4	40	84	17	32
		200.12 SMB 1415	200.12 SMF 1415	M18x1.5	40	78	11	32
		200.12 SMB 1415	200.12 SMB 1415	M22x1.5	40	79	12	32
	19	200.19 SMB 26	200.19 SMF 26	BSP 3/4	54	100	17	46
		200.19 SMB 33	200.19 SMF 33	BSP 1	54	103	20	46
		200.19 SMB 2615	200.19 SMF 2615	M26x1.5	54	95	12	46
		200.19 SMB 3015	200.19 SMF 3015	M30x1.5	54	97	14	46
	32	200.32 SMB 4515	200.32 SMF 4515	M45x1.5	82	128	16	75
	50	200.50 SMB 6520	200.50 SMF 6520	M65x2.0	112	159	18	100



Male long thread socket with 60° sealing cone / Kupplung mit langem Aussengewinde 60° Dichtkonus

TYPE 200

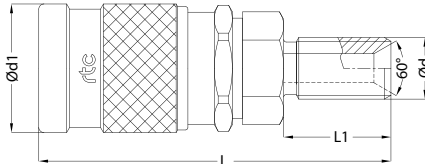

Socket / Kupplung	Size Größe	Order No / Bestellnr. With Valve / Mit Ventil	Order No / Bestellnr. Without Valve / Ohne Ventil	Ød	Ød1	L	L1	HEX.
	06	200.05 SMB 1415x32	200.05 SMF 1415x32	M14x1.5	25	79	32	19
	06	200.06 SMB 1415x32	200.06 SMF 1415x32	M14x1.5	22	79	32	19
	07	200.07 SMB 1615x34	200.07 SMF 161x345	M16x1.5	30	90	34	24
	12	200.12 SMB 2215x49	200.12 SMF 2215x39	M22x1.5	40	106	39	32
	19	200.19 SMB 3015x45	200.19 SMF 3015x45	M30x1.5	54	128	45	46



Male thread socket with 24° sealing cone / Kupplung mit Aussengewinde 24° Dichtkonus

TYPE 200

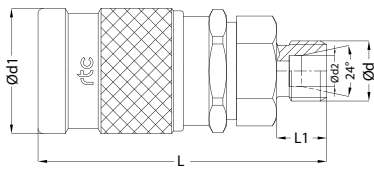

Socket / Kupplung	Size Größe	Order No / Bestellnr. With Valve / Mit Ventil	Order No / Bestellnr. Without Valve / Ohne Ventil	Ød	Ød1	Ød2	L	L1	HEX.
	06	200.05 SMB 1215-06	200.05 SMF 1215-06	M12x1.5	25	6	57	10	19
		200.05 SMB 1415-08	200.05 SMF 1415-08	M14x1.5	25	8	57	10	19
		200.05 SMB 1615-08	200.05 SMF 1615-08	M16x1.5	25	8	59	12	19
		200.05 SMB 1615-10	200.05 SMF 1615-10	M16x1.5	25	10	58	11	19
		200.05 SMB 1815-10	200.05 SMF 1815-10	M18x1.5	25	10	59	12	19
		200.05 SMB 1815-12	200.05 SMF 1815-12	M18x1.5	25	12	58	11	19
		200.05 SMB 2015-12	200.05 SMF 2015-12	M20x1.5	25	12	59	12	22
	06	200.06 SMB 1215-06	200.06 SMF 1215-06	M12x1.5	22	6	57	10	19
		200.06 SMB 1415-08	200.06 SMF 1415-08	M14x1.5	22	8	57	10	19
		200.06 SMB 1615-08	200.06 SMF 1615-08	M16x1.5	22	8	59	12	19
		200.06 SMB 1615-10	200.06 SMF 1615-10	M16x1.5	22	10	58	11	19
		200.06 SMB 1815-10	200.06 SMF 1815-10	M18x1.5	22	10	59	12	19
		200.06 SMB 1815-12	200.06 SMF 1815-12	M18x1.5	22	12	58	11	19
		200.06 SMB 2015-12	200.06 SMF 2015-12	M20x1.5	22	12	59	12	22
	07	200.07 SMB 1415-08	200.07 SMF 1415-08	M14x1.5	30	8	66	10	24
		200.07 SMB 1615-10	200.07 SMF 1615-10	M16x1.5	30	10	67	11	24
		200.07 SMB 1815-10	200.07 SMF 1815-10	M18x1.5	30	10	68	12	24
		200.07 SMB 1815-12	200.07 SMF 1815-12	M18x1.5	30	12	67	11	24
		200.07 SMB 2015-12	200.07 SMF 2015-12	M20x1.5	30	12	68	12	24
	12	200.12 SMB 1615-12	200.12 SMF 1815-12	M18x1.5	40	12	78	11	32
		200.12 SMB 1815-15	200.12 SMF 2215-15	M22x1.5	40	15	79	12	32
		200.12 SMB 2015-16	200.12 SMF 2415-16	M24x1.5	40	16	81	14	32
	19	200.19 SMB 2615-18	200.19 SMF 2615-18	M26x1.5	54	18	95	12	46
		200.19 SMB 3020-20	200.19 SMF 3020-20	M30x2.0	54	20	97	14	46
		200.19 SMB 3020-22	200.19 SMF 3020-22	M30x2.0	54	22	99	16	46
		200.19 SMB 3620-25	200.19 SMF 3020-25	M36x2.0	54	25	101	18	46
	32	200.32 SMB 5220-38	200.32 SMF 5220-38	M52x2.0	82	38	134	22	75
	50	200.50 SMB 5220-42	200.50 SMF 5220-42	M52x2.0	112	42	158	22	100



Male long thread socket with 24° sealing cone / Kupplung mit langem Aussengewinde 24° Dichtkonus

TYPE 200

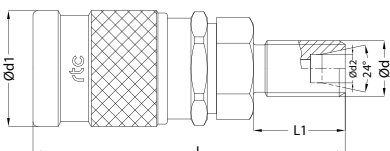

Socket / Kupplung	Size Größe	Order No / Bestellnr. With Valve / Mit Ventil	Order No / Bestellnr. Without Valve / Ohne Ventil	Ød	Ød1	Ød2	L	L1	HEX.
	06	200.05 SMB 1415-08x32	200.05 SMF 1415-08x32	M14x1.5	25	8	79	32	19
		200.05 SMB 1615-10x32	200.05 SMF 1615-10x32	M16x1.5	25	10	79	32	19
	06	200.06 SMB 1415-08x32	200.06 SMF 1415-08x32	M14x1.5	22	8	79	32	19
		200.06 SMB 1615-10x32	200.06 SMF 1615-10x32	M16x1.5	22	10	79	32	19

rtc TYPE 200

Standard hose tail socket / Kupplung mit gerader Standard - Schlauchtülle

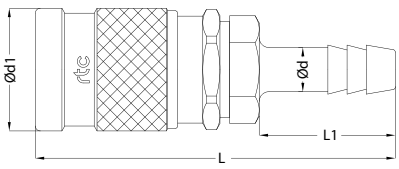
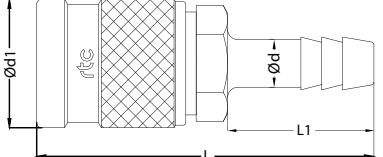

Socket / Kupplung	Size Größe	Order No / Bestellnr. With Valve / Mit Ventil	Order No / Bestellnr. Without Valve / Ohne Ventil	Ød	Ød1	L	L1
	04	200.04 SHB 04	200.04 SHF 04	4 mm	18	50	18
		200.04 SHB 06	200.04 SHF 06	6 mm	18	61	25
	06	200.05 SHB 06	200.05 SHF 06	6 mm	25	72	25
		200.05 SHB 09	200.05 SHF 09	9 mm	25	77	30
		200.05 SHB 11	200.05 SHF 11	11 mm	25	77	30
		200.05 SHB 13	200.05 SHF 13	13 mm	25	77	30
	06	200.06 SHB 06	200.06 SHF 06	6 mm	22	72	25
		200.06 SHB 09	200.06 SHF 09	9 mm	22	77	30
		200.06 SHB 11	200.06 SHF 11	11 mm	22	77	30
		200.06 SHB 13	200.06 SHF 13	13 mm	22	77	30
	07	200.07 SHB 09	200.07 SHF 09	9 mm	30	86	30
		200.07 SHB 11	200.07 SHF 11	11 mm	30	86	30
		200.07 SHB 13	200.07 SHF 13	13 mm	30	86	30
	09	200.09 SHB 13	200.09 SHF 13	13 mm	28	86	30
	12	200.12 SHB 16	200.12 SHF 16	16 mm	40	102	35
		200.12 SHB 19	200.12 SHF 19	19 mm	40	102	35
	19	200.19 SHB 19	200.19 SHF 19	19 mm	54	118	35
		200.19 SHB 25	200.19 SHF 25	25 mm	54	123	40
		200.19 SHB 28	200.19 SHF 28	28 mm	54	128	45
	32	200.32 SHB 42	-	42 mm	82	178	61
		200.32 SHB 53	-	53 mm	82	182	70
	32	-	200.32 SHF 42	42 mm	82	143	61
		-	200.32 SHF 53	53 mm	82	152	70
	50	200.50 SHB 65	-	65 mm	112	209	75
	50	-	200.50 SHF 65	65 mm	112	182	75

Free-Flow Coupling
Kupplung ohne Ventil

rtc TYPE 200

Y Distributor / Y Verteiler

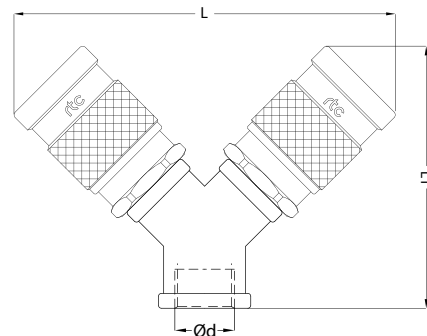
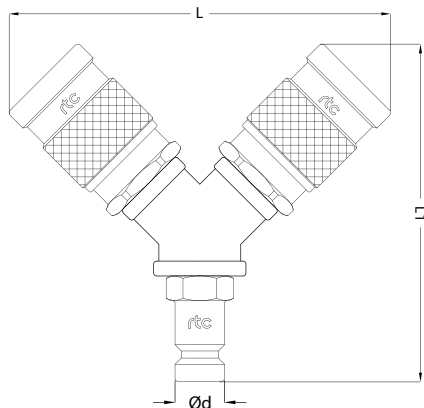

Size Größe	Order No Bestellnr.	Ød	L	L1
6	200.05 SPOY	12	116	110

Size Größe	Order No Bestellnr.	Ød	L	L1
6	200.05 SFOY 17	BSP 3/8	116	81
7	200.07 SFOY 21	BSP 1/2	140	96
12	200.12 SFOY 33	BSP 1	178	128



Female thread plug / Nippel mit Innengewinde

TYPE 200 **rtc**

Plug / Nippel	Size Größe	Order No / Bestellnr. With Valve / Mit Ventil	Ød	Ød1	L	HEX.
	04	200.04 PFB 10	BSP 1/8	18	45	14
		06	200.05 PFB 13	BSP 1/4	25	55
	200.05 PFB 17		BSP 3/8	25	56	22
	06	200.06 PFB 13	BSP 1/4	22	55	19
		200.06 PFB 17	BSP 3/8	22	56	22
	07	200.07 PFB 17	BSP 3/8	30	66	24
200.07 PFB 21		BSP 1/2	30	69	27	
09	200.09 PFB 17	BSP 3/8	28	67	25	
	200.09 PFB 21	BSP 1/2	28	70	27	
12	200.12 PFB 21	BSP 1/2	40	79	32	
	200.12 PFB 26	BSP 3/4	40	81	32	
19	200.19 PFB 26	BSP 3/4	54	90	46	
	200.19 PFB 33	BSP 1	54	94	46	
32	200.32 PFB 48	BSP 1-1/2	82	123	75	
	200.32 PFB 60	BSP 2	82	127	75	
50	200.50 PFB 60	BSP 2	112	154	100	
	200.50 PFB 75	BSP 2-1/2	112	163	100	

Plug profile of 200.04 - 200.06 - 200.09



Male thread plug / Nippel mit Aussengewinde

TYPE 200 **rtc**

Plug / Nippel	Size Größe	Order No / Bestellnr. With Valve / Mit Ventil	Ød	Ød1	L	L1	HEX.
	04	200.04 PMB 10-00	BSP 1/8	18	45	10	14
		200.04 PMB 13-00	BSP 1/4	18	46	11	14
	06	200.05 PMB 13-00	BSP 1/4	25	56	11	19
		200.05 PMB 17-00	BSP 3/8	25	57	12	19
		200.05 PMB 21-00	BSP 1/2	25	60	15	22
	06	200.06 PMB 13-00	BSP 1/4	22	56	11	19
200.06 PMB 17-00		BSP 3/8	22	57	12	19	
200.06 PMB 21-00		BSP 1/2	22	60	15	22	
07	200.07 PMB 17-00	BSP 3/8	30	66	12	24	
	200.07 PMB 21-00	BSP 1/2	30	69	15	24	
09	200.09 PMB 17-00	BSP 3/8	28	67	12	25	
	200.09 PMB 21-00	BSP 1/2	28	70	15	25	
12	200.12 PMB 21-00	BSP 1/2	40	80	15	32	
	200.12 PMB 26-00	BSP 3/4	40	82	17	32	
	200.12 PMB 33-00	BSP 1	40	86	20	36	
19	200.19 PMB 26-00	BSP 3/4	54	96	17	46	
	200.19 PMB 33-00	BSP 1	54	99	20	46	
	200.19 PMB 42-00	BSP 1-1/4	54	101	22	46	
32	200.32 PMB 48-00	BSP 1-1/2	82	136	22	75	
	200.32 PMB 60-00	BSP 2	82	140	26	75	
50	200.50 PMB 60-00	BSP 2	112	158	26	100	
	200.50 PMB 75-00	BSP 2-1/2	112	160	30	100	

Plug profile of 200.04 - 200.06 - 200.09

rtc TYPE 200

Male thread plug with sealing edge / Nippel mit Aussengewinde / Abdichtung am Rand



Plug / Nippel

Size Größe	Order No / Bestellnr. With Valve / Mit Ventil	Ød	Ød1	L	L1	HEX.
06	200.05 PMB 17-SE	BSP 3/8	25	62	12	27
06	200.06 PMB 17-SE	BSP 3/8	22	62	12	27
07	200.07 PMB 17-SE	BSP 3/8	30	69	12	27
12	200.12 PMB 21-SE	BSP 1/2	40	82	14	32
19	200.19 PMB 26-SE	BSP 3/4	54	98	16	46

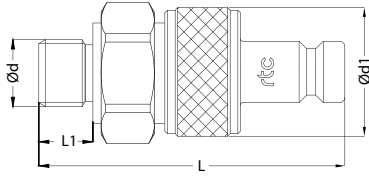

rtc TYPE 200

Male thread plug with 60° sealing cone / Nippel mit Aussengewinde 60° Dichtkonus



Plug / Nippel

Size Größe	Order No / Bestellnr. With Valve / Mit Ventil	Ød	Ød1	L	L1	HEX.
06	200.05 PMB 13	BSP 1/4	25	56	11	19
	200.05 PMB 17	BSP 3/8	25	57	12	19
	200.05 PMB 1415	M14x1.5	25	55	10	19
06	200.06 PMB 13	BSP 1/4	22	56	11	19
	200.06 PMB 17	BSP 3/8	22	57	12	19
	200.06 PMB 1415	M14x1.5	22	55	10	19
07	200.07 PMB 17	BSP 3/8	30	66	12	24
	200.07 PMB 1615	M16x1.5	30	65	11	24
12	200.12 PMB 21	BSP 1/2	40	80	15	32
	200.12 PMB 26	BSP 3/4	40	82	17	32
	200.12 PMB 1815	M18x1.5	40	76	11	32
	200.12 PMB 2215	M22x1.5	40	77	12	32
19	200.19 PMB 26	BSP 3/4	54	96	17	46
	200.19 PMB 33	BSP 1	54	99	20	46
	200.19 PMB 2615	M26x1.5	54	91	12	46
	200.19 PMB 3015	M30x1.5	54	93	14	46
32	200.32 PMB 4515	M45x1.5	82	125	16	75
50	200.50 PMB 6520	M65x2.0	112	159	18	100

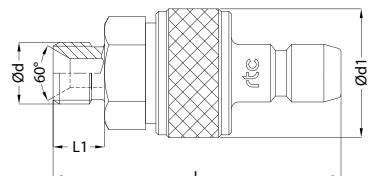
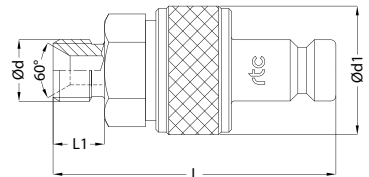

Plug profile of 200.06

rtc TYPE 200

Male long thread plug with 60° sealing cone / Nippel mit langem Aussengewinde 60° Dichtkonus



Plug / Nippel

Size Größe	Order No / Bestellnr. With Valve / Mit Ventil	Ød	Ød1	L	L1	HEX.
06	200.05 PMB 1415x32	M14x1.5	25	77	32	19
06	200.06 PMB 1415x32	M14x1.5	22	77	32	19
07	200.07 PMB 1615x34	M16x1.5	30	88	34	24
12	200.12 PMB 2215x40	M22x1.5	40	104	40	32
19	200.19 PMB 3015x45	M30x1.5	54	124	45	46

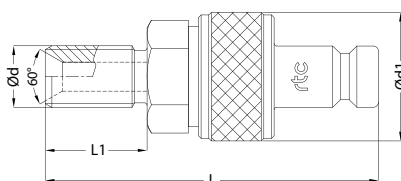



Male thread plug with 24° sealing cone / Nippel mit Aussengewinde 24° Dichtkonus

TYPE 200 

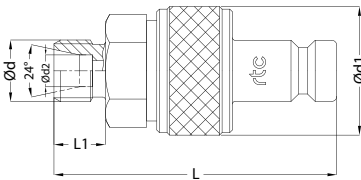
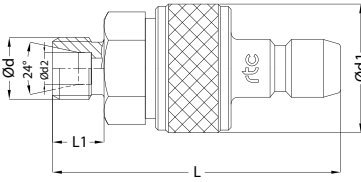
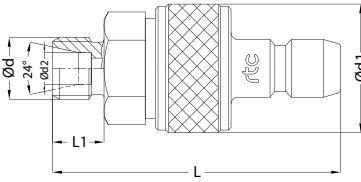
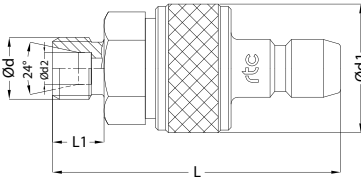
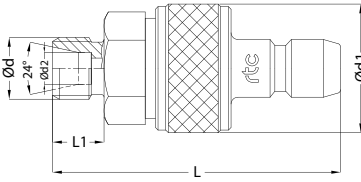
Plug / Nippel	Size Größe	Order No / Bestellnr. With Valve / Mit Ventil	Ød	Ød1	Ød2	L	L1	HEX.
	06	200.05 PMB 1215-06	M12x1.5	25	6 mm	55	10	19
		200.05 PMB 1415-08	M14x1.5	25	8 mm	55	10	19
		200.05 PMB 1615-08	M16x1.5	25	8 mm	57	12	19
		200.05 PMB 1615-10	M16x1.5	25	10 mm	56	11	19
		200.05 PMB 1815-10	M18x1.5	25	10 mm	57	12	19
		200.05 PMB 1815-12	M18x1.5	25	12 mm	56	11	19
		200.05 PMB 2015-12	M20x1.5	25	12 mm	57	12	22
 <p>Plug profile of 200.06</p>	06	200.06 PMB 1215-06	M12x1.5	22	6 mm	55	10	19
		200.06 PMB 1415-08	M14x1.5	22	8 mm	55	10	19
		200.06 PMB 1615-08	M16x1.5	22	8 mm	57	12	19
		200.06 PMB 1615-10	M16x1.5	22	10 mm	56	11	19
		200.06 PMB 1815-10	M18x1.5	22	10 mm	57	12	19
		200.06 PMB 1815-12	M18x1.5	22	12 mm	56	11	19
		200.06 PMB 2015-12	M20x1.5	22	12 mm	57	12	22
	07	200.07 PMB 1415-08	M14x1.5	30	8 mm	64	10	24
		200.07 PMB 1615-10	M16x1.5	30	10 mm	65	11	24
		200.07 PMB 1815-10	M18x1.5	30	10 mm	66	12	24
		200.07 PMB 1815-12	M18x1.5	30	12 mm	65	11	24
		200.07 PMB 2015-12	M20x1.5	30	12 mm	66	12	24
	12	200.12 PMB 1815-12	M18x1.5	40	12 mm	76	11	32
		200.12 PMB 2215-15	M22x1.5	40	15 mm	77	12	32
		200.12 PMB 2415-16	M24x1.5	40	16 mm	79	14	32
	19	200.19 PMB 2615-18	M26x1.5	54	18 mm	91	12	46
		200.19 PMB 3020-20	M30x2.0	54	20 mm	95	16	46
		200.19 PMB 3020-22	M30x2.0	54	22 mm	93	14	46
		200.19 PMB 3620-25	M36x2.0	54	25 mm	97	18	46
32	200.32 PMB 5220-38	M52x2.0	82	38 mm	131	22	75	
50	200.50 PMB 5220-42	M52x2.0	112	42 mm	154	16	100	



Male long thread plug with 24° sealing cone / Nippel mit langem Aussengewinde 24° Dichtkonus

TYPE 200 

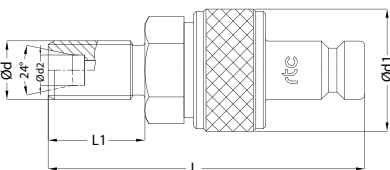
Plug / Nippel	Size Größe	Order No / Bestellnr. With Valve / Mit Ventil	Ød	Ød1	Ød2	L	L1	HEX.
	06	200.05 PMB 1415-08x32	M14x1.5	25	8 mm	77	32	19
		200.05 PMB 1615-10x32	M16x1.5	25	10 mm	77	32	19
	06	200.06 PMB 1415-08x32	M14x1.5	22	8 mm	77	32	19
		200.06 PMB 1615-10x32	M16x1.5	22	10 mm	77	32	19



Standard hose tail plug / Nippel mit gerader Standard - Schlauchtülle

TYPE 200 

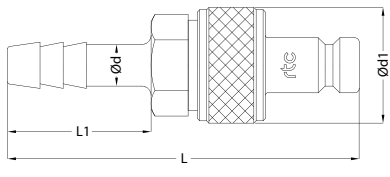
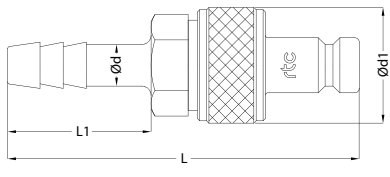
Plug / Nippel	Size Größe	Order No / Bestellnr. With Valve / Mit Ventil	Ød	Ød1	L	L1
	04	200.04 PHB 04	4 mm	18	58	18
		200.04 PHB 06	6 mm	18	65	25
	06	200.05 PHB 06	6 mm	25	70	25
		200.05 PHB 09	9 mm	25	75	30
		200.05 PHB 11	11 mm	25	75	30
		200.05 PHB 13	13 mm	25	75	30

rtc TYPE 200

Standard hose tail plug / Nippel mit gerader Standard - Schlauchtülle



Plug / Nippel

Size
Größe

Order No / Bestellnr.
With Valve / Mit Ventil

Ød

Ød1

L

L1

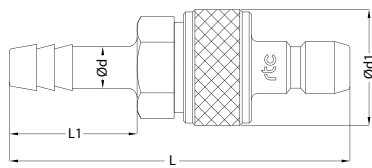
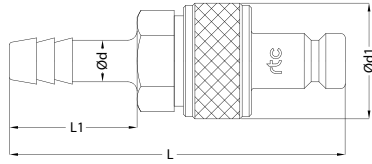

Plug profile of 200.04 - 200.06 - 200.09

06

200.06 PHB 06
200.06 PHB 09
200.06 PHB 11
200.06 PHB 13

6 mm
9 mm
11 mm
13 mm

22
22
22
22

70
75
75
75

25
30
30
30

07

200.07 PHB 09
200.07 PHB 11
200.07 PHB 13

9 mm
11 mm
13 mm

30
30
30

84
84
84

30
30
30

09

200.09 PHB 13

13 mm

28

85

30

12

200.12 PHB 16
200.12 PHB 19

16 mm
19 mm

40
40

100
100

35
35

19

200.19 PHB 19
200.19 PHB 25
200.19 PHB 28

19 mm
25 mm
28 mm

54
54
54

114
119
124

35
40
45

32

200.32 PHB 42
200.32 PHB 53

42 mm
53 mm

82
82

175
179

61
70

50

200.50 PHB 65

65 mm

112

205

75

rtc TYPE 200

Female thread plug without valve / Nippel mit Innengewinde ohneventil



Plug / Nippel

Size
Größe

Order No / Bestellnr.
Without Valve / Ohne Ventil

Ød

Ød1

L

HEX.

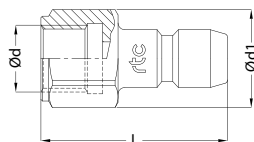
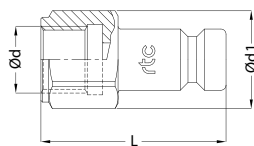

Plug profile of 200.04 - 200.06 - 200.09

04

200.04 PFF 10

BSP 1/8

16

29

14

06

200.05 PFF 10
200.05 PFF 13
200.05 PFF 17

BSP 1/8
BSP 1/4
BSP 3/8

17
19
24

31
36
38

15
17
22

06

200.06 PFF 10
200.06 PFF 13
200.06 PFF 17

BSP 1/8
BSP 1/4
BSP 3/8

17
19
24

31
36
38

15
17
22

07

200.07 PFF 13
200.07 PFF 17
200.07 PFF 21

BSP 1/4
BSP 3/8
BSP 1/2

19
24
30

41
42
45

17
22
27

09

200.09 PFF 17
200.09 PFF 21

BSP 3/8
BSP 1/2

24
30

42
45

22
27

12

200.12 PFF 21
200.12 PFF 26

BSP 1/2
BSP 3/4

33
36

51
53

27
32

19

200.19 PFF 26
200.19 PFF 33

BSP 3/4
BSP 1

40
45

58
60

36
41

32

200.32 PFF 42
200.32 PFF 48
200.32 PFF 60

BSP 1-1/4
BSP 1-1/2
BSP 2

60
65
78

71
71
75

55
60
70

50

200.50 PFF 60

BSP 2

92

82

85



Male thread plug without valve / Nippel mit Aussengewinde ohneventil

TYPE 200

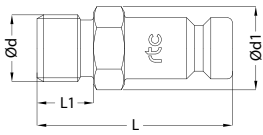

Plug / Nippel	Size Größe	Order No / Bestellnr. Without Valve / Ohne Ventil	Ød	Ød1	L	L1	HEX.
	04	200.04 PMF 10	BSP 1/8	16	29	8	14
		200.04 PMF 13	BSP 1/4	16	32	11	14
		200.04 PMF 1010	M10x1.0	15	28	8	13
	06	200.05 PMF 10	BSP 1/8	16	34	8	14
		200.05 PMF 13	BSP 1/4	16	37	11	14
		200.05 PMF 17	BSP 3/8	21	38	12	19
	06	200.06 PMF 10	BSP 1/8	16	34	8	14
		200.06 PMF 13	BSP 1/4	16	37	11	14
		200.06 PMF 17	BSP 3/8	22	38	12	19
07	200.07 PMF 13	BSP 1/4	19	41	11	17	
	200.07 PMF 17	BSP 3/8	21	42	12	19	
	200.07 PMF 21	BSP 1/2	27	45	15	24	
09	200.09 PMF 17	BSP 3/8	22	42	12	19	
	200.09 PMF 21	BSP 1/2	24	47	15	22	
12	200.12 PMF 17	BSP 3/8	30	50	12	27	
	200.12 PMF 21	BSP 1/2	30	55	15	27	
	200.12 PMF 26	BSP 3/4	33	55	17	30	
19	200.19 PMF 21	BSP 1/2	40	58	15	36	
	200.19 PMF 26	BSP 3/4	40	60	17	36	
	200.19 PMF 33	BSP 1	40	63	20	36	
32	200.32 PMF 48	BSP 1-1/2	60	75	22	55	
	200.32 PMF 60	BSP 2	73	79	26	65	
50	200.50 PMF 60	BSP 2	92	88	26	85	

Plug profile of 200.04 - 200.06 - 200.09



Standard hose tail plug without valve / Nippel mit gerader Standard - Schlauchtülle ohneventil

TYPE 200

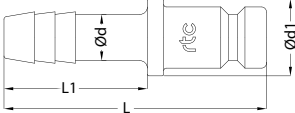

Plug / Nippel	Size Größe	Order No / Bestellnr. Without Valve / Ohne Ventil	Ød	Ød1	L	L1
	04	200.04 PHF 04	4 mm	12	37	18
		200.04 PHF 06	6 mm	12	44	25
	06	200.05 PHF 06	6 mm	11	46	26
		200.05 PHF 09	9 mm	11	51	31
		200.05 PHF 11	11 mm	14	53	33
	06	200.06 PHF 06	6 mm	12	46	26
200.06 PHF 09		9 mm	12	51	31	
200.06 PHF 11		11 mm	16	53	33	
07	200.07 PHF 09	9 mm	14	55	30	
	200.07 PHF 11	11 mm	18	57	30	
	200.07 PHF 13	13 mm	18	57	30	
09	200.09 PHF 13	13 mm	15	55	30	
12	200.12 PHF 13	13 mm	21	61	30	
	200.12 PHF 16	16 mm	21	66	35	
	200.12 PHF 19	19 mm	25	69	35	
19	200.19 PHF 19	19 mm	32	69	35	
	200.19 PHF 25	25 mm	32	74	40	
32	200.32 PHF 42	42 mm	54	105	61	
	200.32 PHF 53	53 mm	60	114	70	
50	200.50 PHF 65	65 mm	90	131	75	

Plug profile of 200.04 - 200.06 - 200.09